



By Appointment
To His Royal Highness The Duke of Edinburgh
Suppliers of Vespa Scooters

vespa

Super Sport 180 cc

OPERATION AND MAINTENANCE

DOUGLAS (SALES & SERVICE) LTD.,
2 OAK LANE, FISHPONDS TRADING ESTATE, BRISTOL, BS5 7XB
Telephone 654197 or 654882

scooterhelp.com



DIVISION OF THE WESTINGHOUSE BRAKE AND SIGNAL COMPANY LIMITED



By Appointment
To His Royal Highness The Duke of Edinburgh
Suppliers of Vespa Scooters

vespa

Super Sport 180 cc

OPERATION AND MAINTENANCE

DOUGLAS (SALES & SERVICE) LTD.,
2 OAK LANE, FISHPONDS TRADING ESTATE, BRISTOL, BS5 7XB
Telephone 654197 or 654882

DIVISION OF THE WESTINGHOUSE BRAKE AND SIGNAL COMPANY LIMITED



scooterhelp.com

INDEX

	Page		Page
Layout of controls	4	Operating instructions: Fault finding	38
Introduction	6	Engine: description	41
Performance and specifications	8	Chassis: description	41
Operating instructions	11	Accessories	42
Running-in	13	Electrical equipment	42
Maintenance	17	Identification data	45
Summary of Instructions for Maintenance	36		

NOTICE

To keep your VESPA in perfect running order and not to invalidate the guarantee offered by the contract, it is advisable to entrust repairs only to retailers or authorized service stations.

Demand original VESPA spare parts exclusively. All VESPA spares are made of the same material, have undergone the same machining steps and inspections as the components of your VESPA. This means guarantee for long life and normal performance of your machine and for your personal safety.

Special care should be taken with regard to fuel mixture which should consist of a good quality petrol and oil of make, grade and in the amount prescribed in this booklet, page 16.

SERVICE EXCHANGE

Ask your Dealer for full particulars to the Service Exchange Scheme. The use of the facilities we offer through this medium ensures an economical, speedy, and reliable means of carrying out repairs when such become necessary.

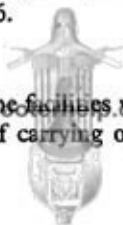



Fig. 1—Vespa "Super Sport".

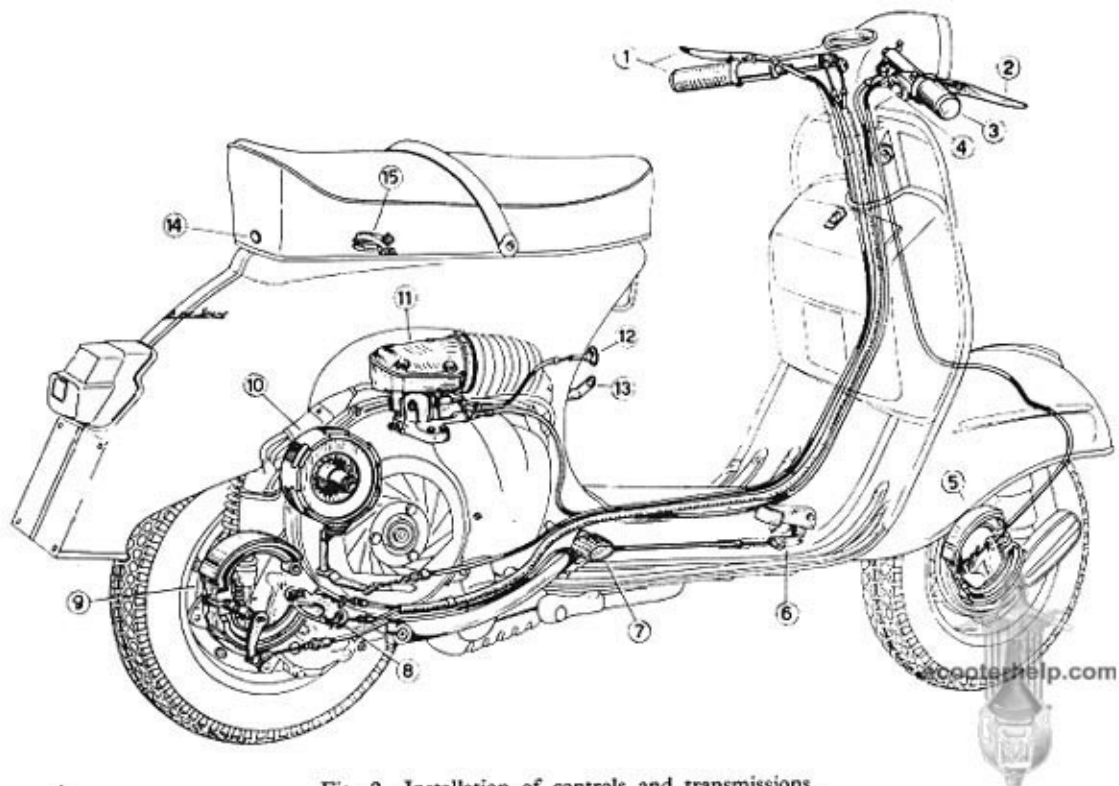

Fig. 2

1. Gear change twist grip and clutch control lever.
2. Front brake lever.
3. Throttle twist grip.
4. Main switch unit with horn button.
5. Front brake shoes.
6. Rear brake pedal.
7. Kickstarter.
8. Gear selector.
9. Rear brake shoes.
10. Clutch.
11. Carburettor and

air cleaner. 12. Choke control. 13. Fuel tap. 14. Release button for dual seat. 15. Filler cap.

Note: In order to gain access to the fuel tank, push on the button No. 14 and release the seat; then swivel upwards.



INTRODUCTION

DOUGLAS (Sales and Service) Ltd. takes this opportunity of thanking you for your choice of this excellent model Vespa. We trust that this scooter will give you complete satisfaction.

You will appreciate the matchless performance of the Vespa "Super Sport" both as regards to its sports and touristic aspects (high speed, brilliant pick-up, very good suspensions and road-holding, quiet engine, elegance, etc.).

Long journeys on your scooter will not fatigue you and you will no doubt be quick to note its excellent performance and especially its high speed.

This booklet, with its **simple instructions** on operation and maintenance will furnish you all the information necessary for obtaining a complete working knowledge of your vehicle.



1. Steering column and front suspension.
2. Engine.
3. Crankcase clutch side with swinging arm pivoted to frame.
4. Rear suspension spring and hydraulic damper assembly.

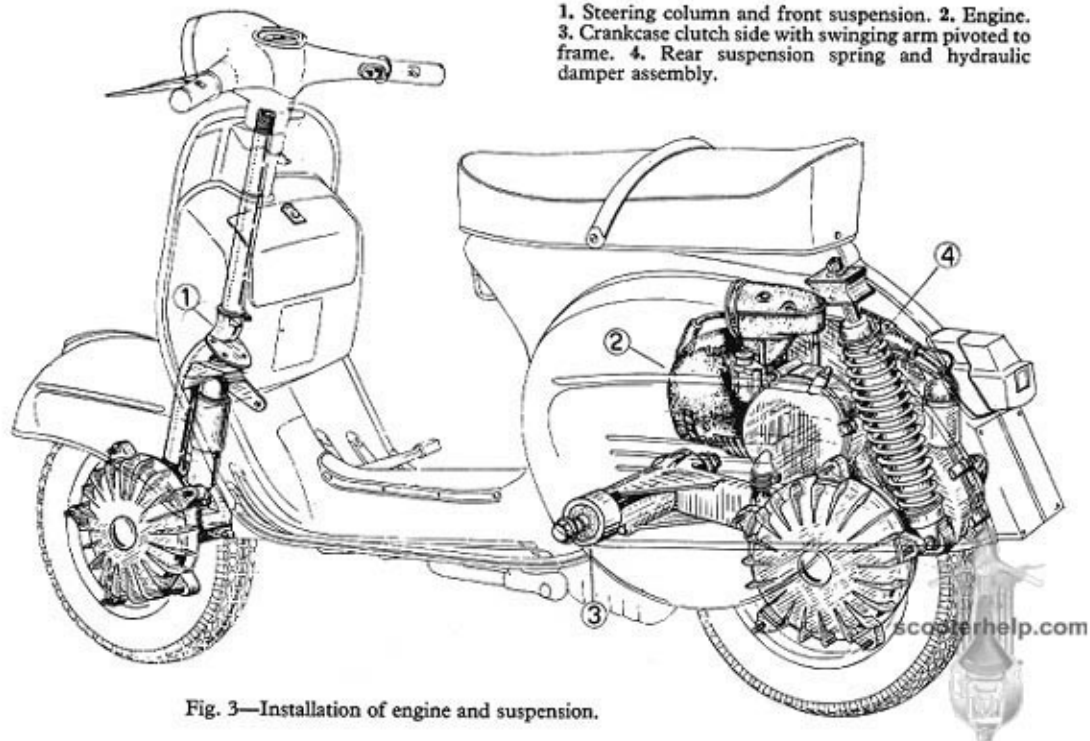

Fig. 3—Installation of engine and suspension.

PERFORMANCE AND SPECIFICATIONS

Consumption (according to CUNA Standards): 2.8 lt/100 Km. (85 mls./U.S. gal.; 102 mls./imp. galls. approx.). Petrol-oil mixture i.e. 5% oil.

Max. speed (CUNA Standards) 105 Km/h (65.3 m.p.h. approx.).

Carrying capacity 2 persons and 10 Kg. (22 lbs.) of luggage.

Range 320 Km. (200 mls.)

Max. fuel capacity: 9 lt. (2.4 U.S. galls. or 1.98 imp. galls.) (incl. 1.8 lt.-0.47 U.S. galls. or 0.39 imp. galls. of reserve).

SIZES AND WEIGHT

Wheel base 1230 mm. (48.4")

Handlebar width 670 mm. (26.3")

Total length 1770 mm. (69.6")

Max. height 1065 mm. (41.9")

Min. ground clearance 120 mm. (4.7")

Turning radius 1400 mm. (55.0")

Total dry weight 99.5 Kg. (219.3 lbs.)

ENGINE: single horizontal cylinder two stroke engine with cross flow scavenging and flat top piston.

Bore 62 mm. (2.44"). Stroke 60 mm. (2.36"). Cylinder displacement 181.145 cc. Compression ratio 7.7 : 1.

H.T. Flywheel external coil **ignition.**

Spark advance: $26^{\circ} \pm 1^{\circ}$ before T.D.C.

Spark plug types: Marelli CW 250 L-T,

CW 240 G or CW 240 B; Champion NA 8;

Bosch W 240 T 2; K.L.G. FE 80; Lodge 2

H LN.

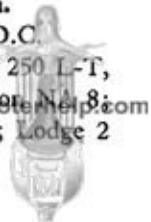

1. Group carburettor air cleaner. 2. Piston. 3. Crankshaft. 4. Clutch. 5. Mainshaft and gear pinion assembly. 6. Gear selector. 7. Flywheel magneto. 8. Kickstarter. 9. Crankcase swinging arm clutch side (pivoted to the frame).

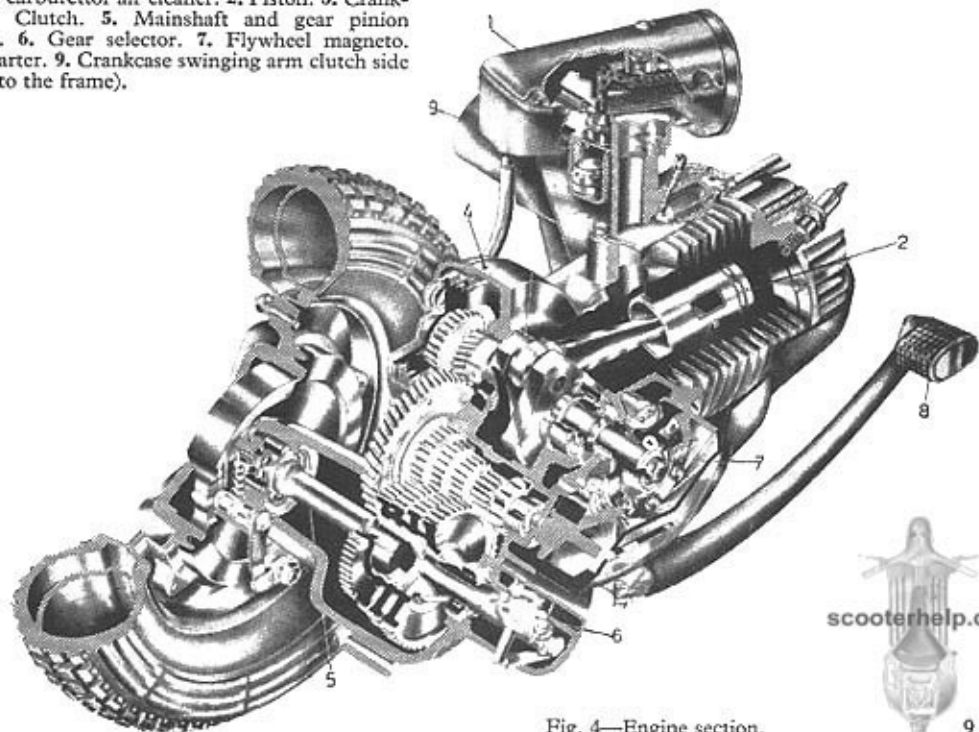

Fig. 4—Engine section.

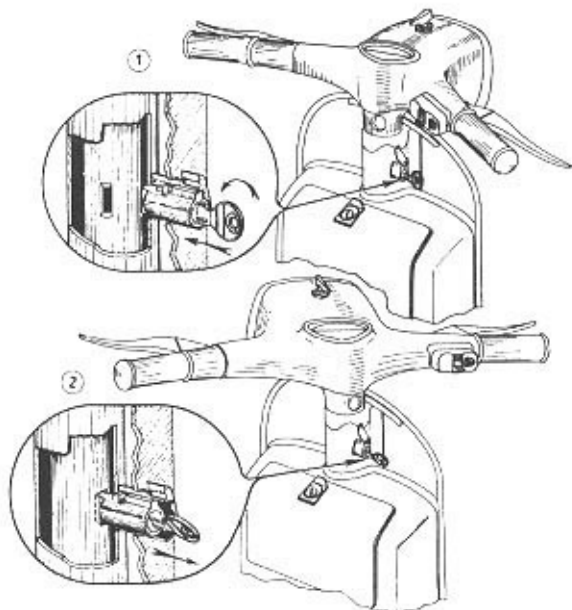

Fig. 5—Steering lock on the steering column.

1. Normal position and locking operation. 2. Locked position and unlocking operation.

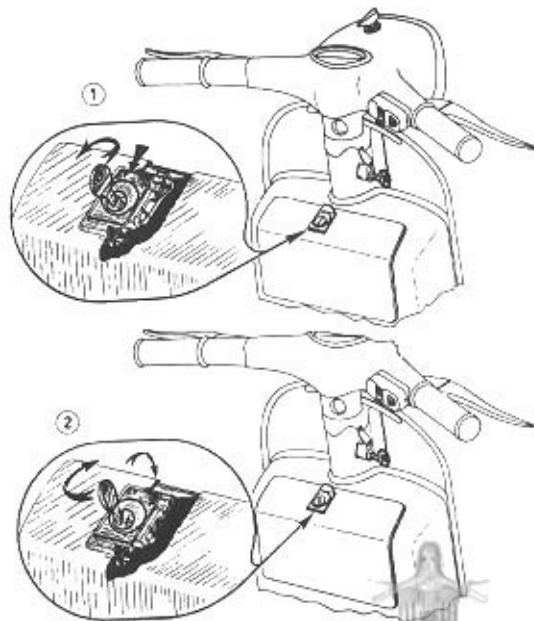

Fig. 6—Front tool box www.scooterhelp.com

N.B.—The arrow indicates the operation to be carried out for unlocking (1) and for locking (2) the tool box.

OPERATING INSTRUCTIONS

Operation	Instructions	Notes
<p>SECURITY LOCK</p> <p>1. Steering lock a) Locking the handlebars</p>	<p>The vehicle is provided with two security devices, one relates to the steering column (locking and unlocking the handlebar) and the other one for locking the front tool box. Both operated by a common key.</p> <p>To lock the vehicle it is necessary to turn the handlebars anticlockwise to the limit stop; rotate the key and push inwards. So that it thrusts the sliding bar against the steering column (see fig. 5). To ease the insertion of the sliding bar into the hole of the steering column, slightly turn the handlebars from the limit stop clockwise. When the handlebars are locked the key will now spring back to its original position and can be extracted.</p>	<p>The steering lock should not be lubricated.</p> <p>The key can be extracted from the lock if the handlebars are free.</p>



OPERATING INSTRUCTIONS

Operation	Instructions	Notes
b) Unlocking the handlebars 2. Front tool box lock	<p>To release the handlebars, insert the key in the lock, turn it to the left and pull it back; then turn the handlebars in the normal position.</p> <p>To open the flap door of the front box insert the key in the lock and turn it anti-clockwise, then slide down the external plate of the lock (fig. 6). In order to close it, shut the flap door and press down until the lock clicks against the tool box; then turn the key clockwise and extract it.</p>	



OPERATING INSTRUCTIONS

Operation	Instructions	Notes
FUEL SUPPLY BEFORE OPERATING THE VEHICLE	<p>Use a mixture of oil and petrol (i.e. 5%). See lubrication Chart. For access to fuel tank pivot the seat on its forward edge, after having released the rear attachment as shown at fig. 2.</p> <p>Unscrew the plug on the gear box marked "OLIO" (fig. 17) and check that the oil is level with the hole when the vehicle is standing upright.</p>	<p>Ensure that the fuel tank breather is always clean. Use a mixture 5% by volume during and after running-in.</p>

For running in first 2000 Km. (1200 mls.), do not keep throttle fully open for long periods.

- **After first 1000 Km. (600 mls.)** change oil in gear box and check that all nuts and bolts are tight.
- **Check tyre pressure:**
Front: 1.2 Kg/cm² (17 lbs./sq. in.); **Rear:** 1.75 Kg/cm² (25 lbs./sq. in.) with one up; **Rear:** 2.5 Kg/cm² (35 lbs./sq.in.) with two up.



scooterhelp.com

OPERATING INSTRUCTIONS

Operation	Instructions	Notes
<p>STARTING</p>	<p>— Carry out the operations indicated on fig. 7. Do not use the choke when the engine is warm; as soon as the engine is running smoothly bring the choke control back to its normal position.</p>	<p>In case of hard starting see page 18.</p>
<p>SETTING THE SCOOTER IN MOTION</p>	<p>— With the engine running at idling speed declutch and rotate the gear change twist grip to the position of first gear (fig. 7). For setting the vehicle in motion slowly let in the clutch and gradually open the throttle.</p>	
<p>GEAR CHANGE</p>	<p>— Close the throttle, declutch and rotate the gear change grip to a higher or lower gear, as the case may be (fig. 7).</p>	<p>When it is necessary to decelerate do not hesitate in changing down.</p>
<p>STOPPING THE ENGINE</p>	<p>— Before stopping the engine change to "neutral" and then switch off ignition.</p>	

A. Open the fuel tap. **B.** Selector neutral. **C.** Pull out the choke control rod (with cold engine). **D.** Bring throttle twist grip to idling position. **E.** Depress kick-starter.

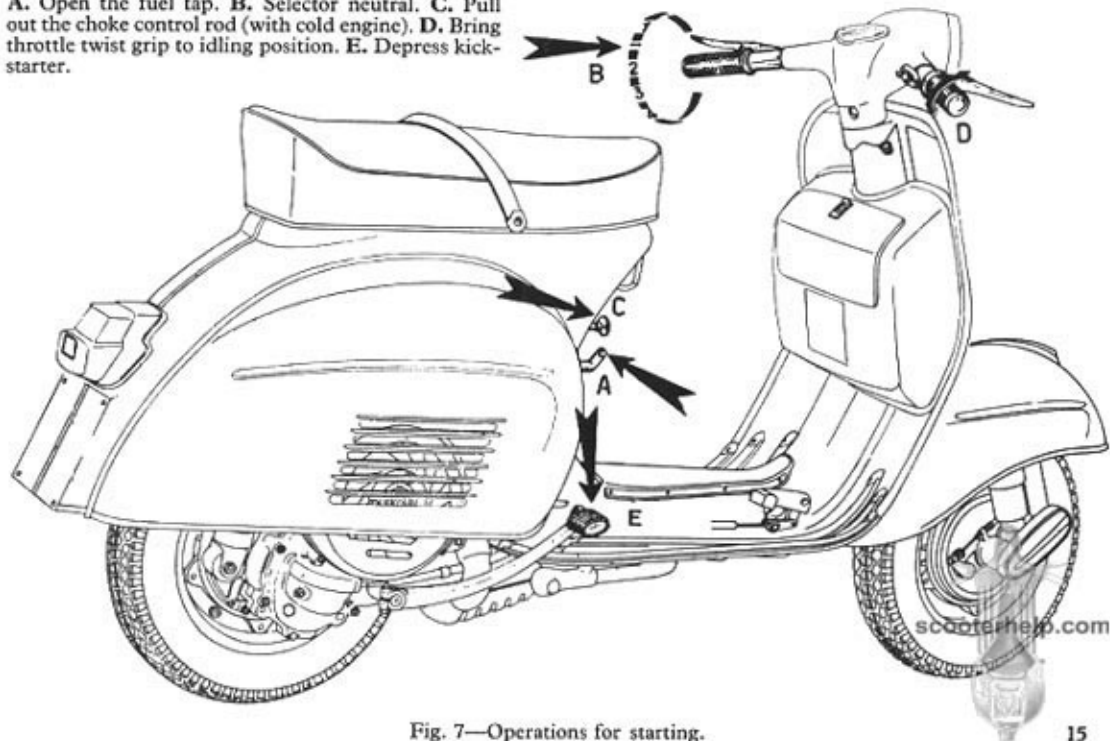

Fig. 7—Operations for starting.

LUBRICATION CHART FOR VESPA 180 c.c. "SUPER SPORT"

Part to be lubricated		Lubrication				
Every 2,500	Every 5,000	*Shell	*B.P.	Esso	Wakefield	Mobil
Gear-box topping-up	Gear-box change oil	Shell 2T Two-Stroke Oil or Shell X-100 30	Energol Two-Stroke Oil or Energol SAE. 30	Esso Extra Motor Oil 20W/30	Castrol XL	Mobiloil A
Front suspension Felt pad on fly-wheel cam Joints on brake control Speedo flexible drive	Control cables Gear change quadrant	Retinax A	Energrease L2	Esso Multi-Purpose Grease H	Castrolase L.M.	Mobilgrease M.P.
Engine at each re-fuelling		Shell 2T Two-Stroke Oil in ratio of 5% or 1-pint to 1 1/2 galls. petrol	Energol Two-Stroke Oil in ratio of 5% or 1-pint to 1 1/2 galls. petrol	Essolube 30 in ratio of 5% or 1-pint to 1 1/2 galls. petrol. Esso Two-Stroke Motor Oil in ratio of 1-pint to 1 1/2 galls. petrol	Castrol XL in ratio of 5% or 1-pint to 1 1/2 galls. petrol. Castrol Two-Stroke Oil in ratio of 1-pint to 1 1/2 galls. petrol	Mobiloil A in ratio of 5% or 1-pint to 1 1/2 galls. petrol or Mobil-Mix in ratio of 1-pint to 1 1/2 galls. petrol

*Marketed also by National Benzole Co. Ltd., by arrangement with Shell-Mex & B.P. Ltd.

APPROVED PETROL/OIL MIXTURE

Make:

Shell
B.P.
National Benzole Co. Ltd.

Description:

2T Two-Stroke Mixture
B.P.-Zoom
Hi-Fli

Hydraulic Dampers:

When not working efficiently consult your Dealer. If servicing is required, they should always be returned to the Manufacturer.

The greases specified on this chart should also be used for the speedometer pinion and front wheel bearing and for the main bearing on the flywheel side of the crankshaft during overhauls.



OPERATING AND MAINTENANCE: COMMON OPERATIONS TO CARRY OUT

Fig. 8—Removing engine cowl.

1. Lever for locking cowl.
2. Front locating pin.
3. Clasp securing cowl to chassis.
4. Rear hooked pivot pin.

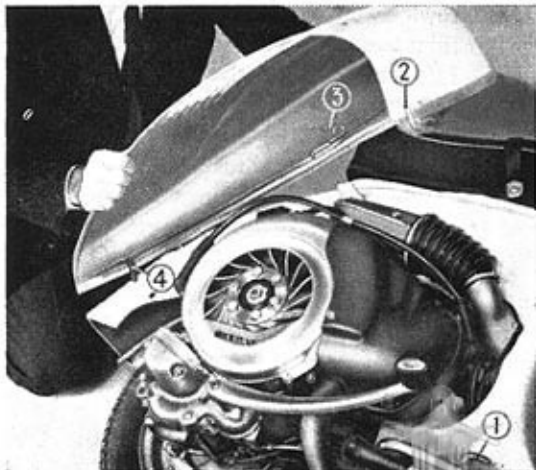

scooterhelp.com



OPERATING AND MAINTENANCE: COMMON OPERATIONS TO CARRY OUT

REMOVAL OF ENGINE COWLING

- Pull the lever "1" and turn to release from cowl. Swing the cowl outwards so that the front locating pin "2" is free of its housing.
- Lift the cowl from the front upwards and swivel on its lower section: so as to release the clasp "3" from the chassis bracket.
- Pull the cowl outwards on the locating pin "4" so that the latter clears its housing.

For reassembly carry out the reverse procedure.

ADJUSTMENTS ON CARBURETTOR

For adjusting the idling turn the slow running adjuster screw (fig. 10 No. 6).

- On the carburettor body a set screw is provided for adjusting the throttle cable play; this screw is to be reset **only if necessary** or on dismantling and reassembly operations.
- In order to regulate the air to the idling jet,

the carburettor is provided with an adjusting screw No. 12, Fig. 10.

However, **we recommend that, unless otherwise unavoidable, customers should avoid resetting this screw.** Any alteration should preferably be entrusted to a Service Station.

STARTING UP when the engine is flooded:

In the case of difficulties caused by flooding (presence of unvaporised mixture in the cylinder), the following methods can be used:

- Attempt push starting: engage 2nd gear, declutch, push the vehicle to a certain speed, sharply release the clutch and when the engine fires declutch immediately.
- Close the fuel tap, remove the sparking plug (see page 25) and clean; then kick over the engine several times. Screw in the sparking plug and tighten, open the fuel tap and start the engine.



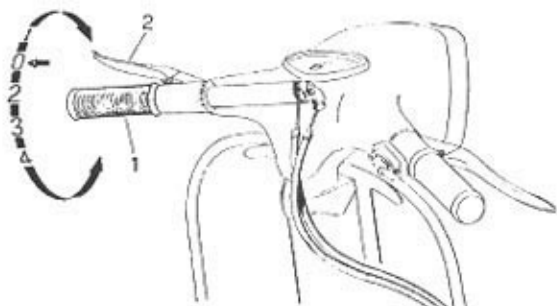
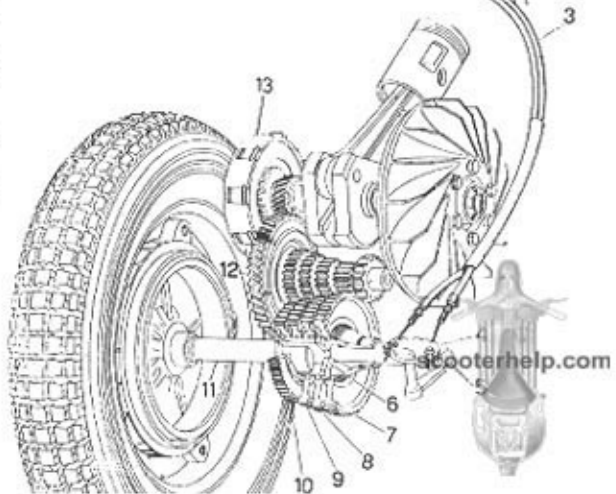

Fig. 9—Gear transmission.

1 Gear change twist grip. 2. Clutch control lever. 3. Gear change cables. 4. Gear selector. 5. Selector stem. 6. Selector spider. 7. 1st gear. 8. 2nd gear. 9. 3rd gear. 10. Top gear. 11. Mainshaft. 12. Spring gear. 13. Clutch.

N.B.—The positions 1, 2, 3, 4 on the gear change twist grip correspond to bottom, 2nd, 3rd and top gear respectively; the "0" indicates neutral.



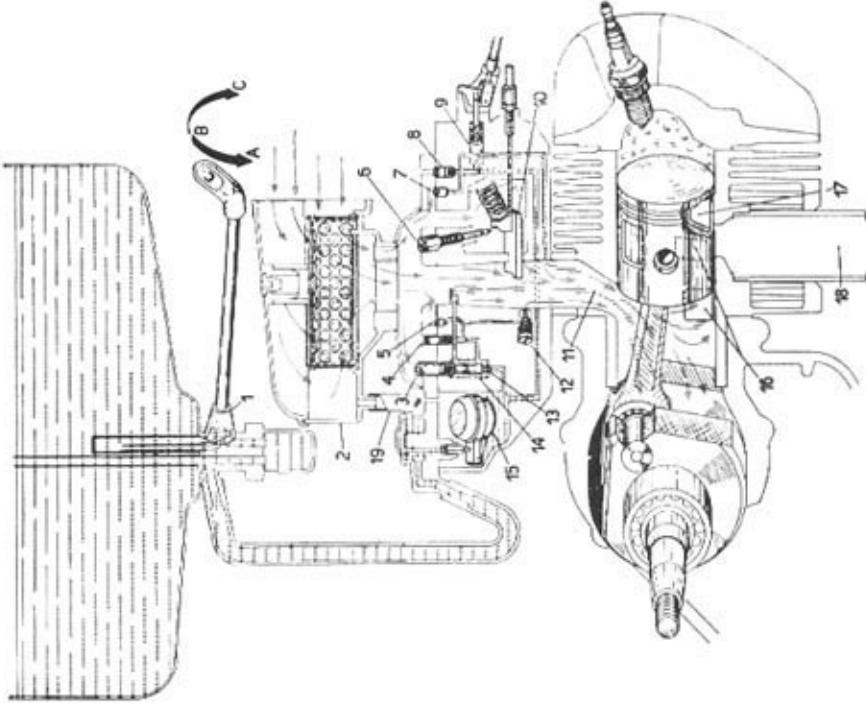

Fig. 10—Fuel supply and distribution diag.

1. The way tap (A. Reserve; B. Open; C. Closed). 2. Air cleaner.
3. Air corrector jet. 4. Slow running jet. 5. Air calibrator to idling jet.
6. Throttle slide set screw. 7. Air calibrator to starter jet. 8. Starter jet.
9. Slow running jet. 10. Throttle slide. 11. Intake port. 12. Slow running adjust screw. 13. Main jet. 14. Mixer. 15. Float and chamber.
16. Cylinder transfer ports. 17. Piston transfer port. 18. Exhaust port.
19. Exhaust duct for excess fuel.

OPERATING AND MAINTENANCE: COMMON OPERATIONS TO CARRY OUT

Operation	Instructions	Notes
CHANGING WHEELS AND TYRES	<ul style="list-style-type: none">— For dismantling the wheels from the vehicle remove the nuts as indicated in fig. 11. On reassembly tighten said screws alternately and progressively.— When a tyre has to be removed, first deflate and then remove the nuts joining the two wheel rims (fig. 12).	The front and rear wheel are interchangeable one with another provided that the tyre pressures are adjusted accordingly (page 13).
DISMANTLING THE SPARE WHEEL	<ul style="list-style-type: none">— Dismantle the spare wheel cowl, following the instructions given for engine cowl (see page 17). To release the wheel unscrew the bolt securing it to the lower section of the protective plate, then the two bolts securing the upper part of the wheel (fig. 13).	



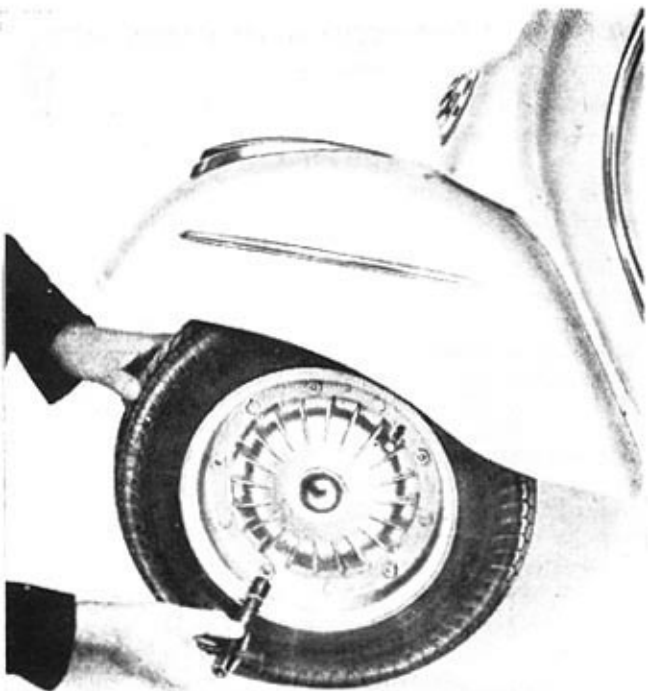

Fig. 11—Removing wheel from vehicle.



Fig. 12—Tyre removal.



Fig. 13—Dismantling of spare wheel.

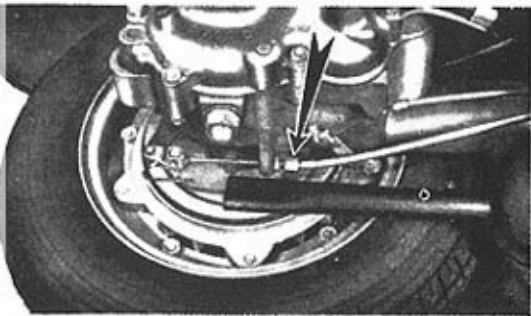
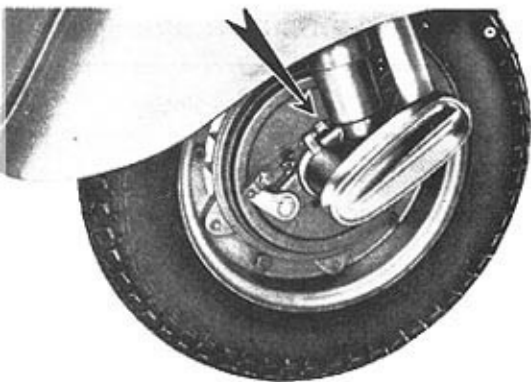

Fig. 14—Front and rear brake adjustment.

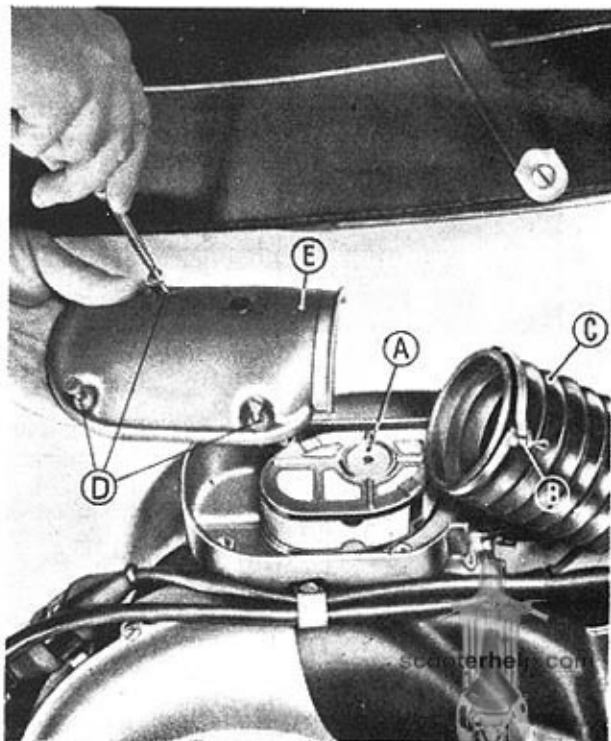



Fig. 15—Dismantling the air cleaner.

OPERATING AND MAINTENANCE: COMMON OPERATIONS TO CARRY OUT

Operation	Instructions	Notes
BRAKE ADJUSTMENT	<p>Brakes are properly adjusted when</p> <ul style="list-style-type: none">— the wheel rotates freely when respective control lever or pedal are in resting position.— the braking action starts as soon as respective controls are operated. These conditions are obtained adjusting the cables by means of screws indicated with an arrow in fig. 14.	
DISMANTLING AIR FILTER	<ul style="list-style-type: none">— To withdraw the air filter "A" from the air filter case (see fig. 15) remove the engine cowl (fig. 8) and air cleaner case cap "E": that is carried out by releasing the collar "B", separate the bellows "C" from the air cleaner and unscrew the securing screws "D". <p>Note: On the bottom of the air cleaner case (the air cleaner removed) there are the two screws that secure the case to the carburettor: in order to dismantle it, unscrew said screws.</p>	<p>On assembling secure properly the collar "B" on the bellows.</p>  <p>scooterhelp.com</p>

OPERATING AND MAINTENANCE: COMMON OPERATIONS TO CARRY OUT

Operation	Instructions	Notes
<p>SPARKPLUG REMOVAL</p>	<p>— Remove engine cowl (Fig. 8), disconnect the H.T. lead and extract the spark-plug using the box wrench as indicated in fig. 16.</p>	<p>On reassembling the spark-plug ensure that it is entered into the threaded hole at the correct angle.</p>
<p>CHANGING OIL IN GEAR CASE</p>	<p>— Drain off through hole (fig. 17). Clean carefully the magnetic drain plug.</p> <p>— Introduce a small quantity of flushing oil, run the engine a few minutes to ensure thorough circulation and cleaning and drain off again.</p> <p>— Afterwards refill gear case with about 220 grs. (250 cc.) of fresh oil (up to level of filling hole).</p>	<p>This operation of changing oil should be carried out with warm engine.</p>



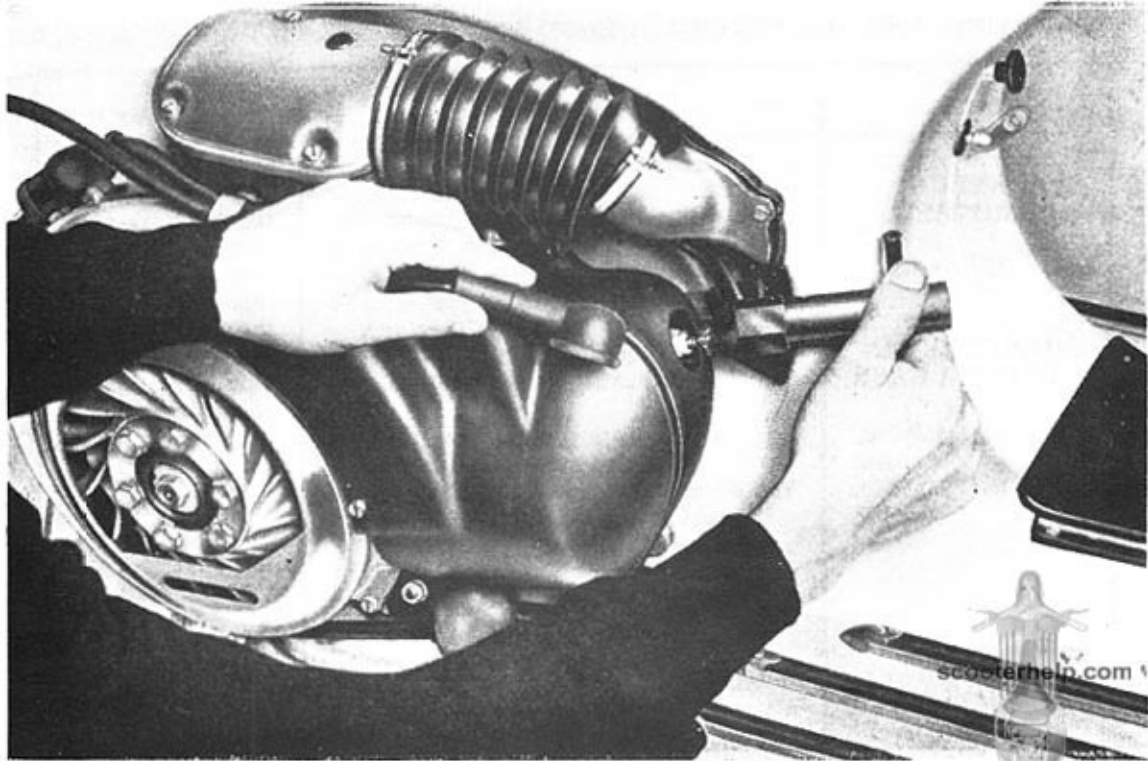

Fig. 16—Spark-plug removal.



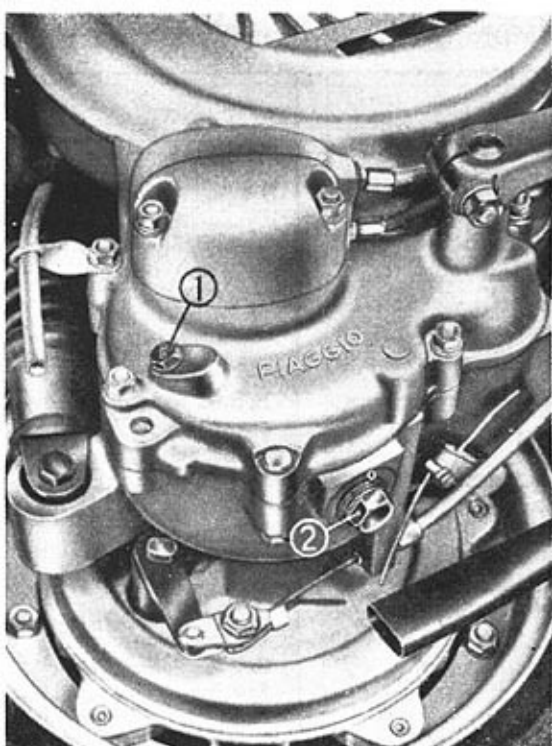

Fig. 17—Oil filler hole (1); oil draining hole (2).

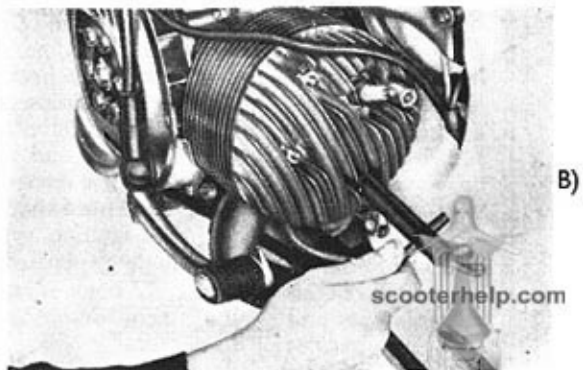
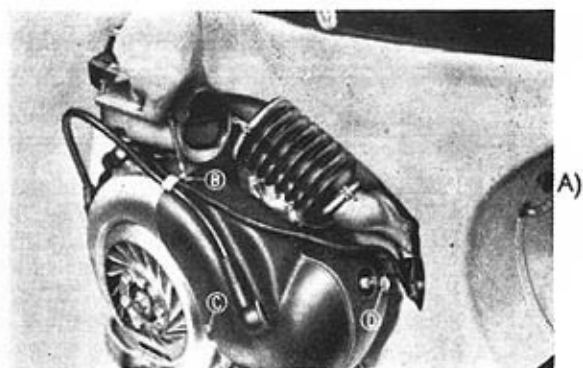

Fig. 18—Dismantling cooling hood from engine (A) and head (B).

OPERATING AND MAINTENANCE: COMMON OPERATIONS TO CARRY OUT

Operation	Instructions	Notes
DISMANTLING CYLINDER HEAD	— Remove engine cowling and air cleaner assembly (fig. 8) (on fig. 18 the air cleaner is already lifted), disconnect the H.T lead, dismantle the "Cooling hood" (screws "B", "C", "D" fig. 18); and unscrew the 4 securing bolts by means of a box wrench.	
SUBSTITUTING BULBS	— Should one of the bulbs in the head-lamp become defective, before substituting, check that the rear parking light bulb is serviceable and vice versa.	Before switching on the new light bulbs, check (on assembly), that the socket contact points are efficient.
CHECKING THE TIMING	— To ensure that maximum efficiency of the ignition system is obtained at all engine speeds, proceed as follows.	If necessary to check the spark advance, consult the Service Station.

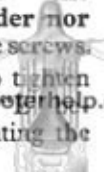

OPERATING AND MAINTENANCE: COMMON OPERATIONS TO CARRY OUT

Operation	Instructions	Notes
<p>CHECKING AND SETTING THE FLYWHEEL MAGNETIC TIMING</p>	<ol style="list-style-type: none"> 1. Take off the rotor of the flywheel by removing the nuts securing it to the hub "A" (on fig. 19 the rotor is already dismantled). 2. Selector in neutral (fig. 9), rotate by hand the hub "A" and line up the mark "B" with the centre of the crankshaft and with extremity of the coil "C" (see fig. 19). 3. At the position as per point 2 the contact breaker points "D" should start to open; the max. opening by rotating again the hub "A" by hand, should enter between the limits 0.3 to 0.5 mm. (0.011" to 0.019"). 4. If the conditions as per point 3 are not obtained, unscrew the screw "F" until foresaid conditions are obtained. 	<p>In order not to upset the mechanical timing (spark advance) do not dismantle the coils holder nor unlock the screws.</p> <p>Be sure to tighten the screw before mounting the rotor.</p> 

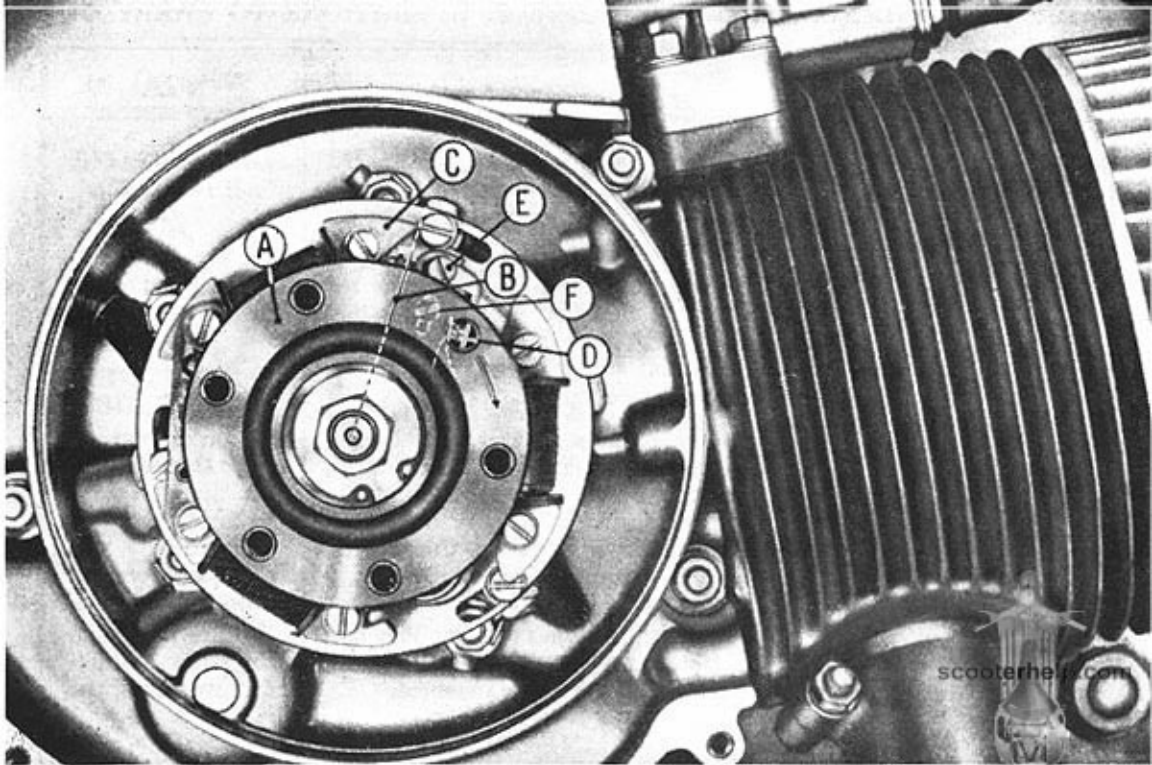

Fig. 19—Operations for checking the "magnetic" timing of the flywheel.

SETTING THE HEADLAMP

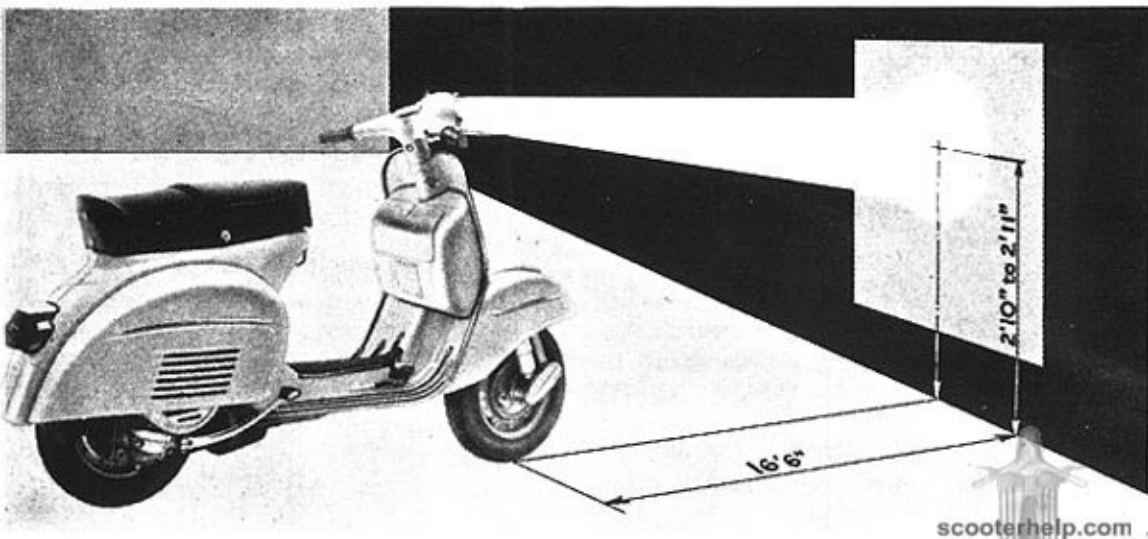

Fig. 20—Setting the headlamp.

N.B.—The point “+” is valid for setting with one or two persons mounted.

OPERATING AND MAINTENANCE: COMMON OPERATIONS TO CARRY OUT

Operation	Instructions	Notes
SETTING THE HEADLAMP	<p>The correct setting of the headlamp can be obtained by slackening the set screws which secure the light unit in the handlebar housing. Before starting the operation, check that the front and rear tyres are inflated to their correct pressures; i.e. 1.2 and 2.5 Kg./cm² (17 lbs./sq. in. and 35 lbs./sq. in.) then position the vehicle in front of a white screen as indicated at fig. 20.</p> <p>Start up the engine, set the throttle at about 1/3 full and switch on the main beam: with two persons mounted register the set screws so that the beam centre coincides with the "+" marked on the screen.</p>	<p>Do not wipe down with a cloth or contact with finger the reflector.</p> <p>The setting operation can be effected with only the driver mounted providing that if a passenger is to be carried the beam is reset.</p>

scooterhelp.com



MAINTENANCE

If starting or running difficulties occur, **check the spark plug:**

— Clean the spark plug electrodes with a steel wire or emery cloth and adjust the gap 0.6 mm. (0.23"). Check porcelain insulation: if cracked or broken change the plug.

Clean in neat petrol.

Do not change the type of spark plug as recommended by manufacturer.

Every 2000 Km. (1200 mls.):

Check oil level in gear case (see fig. 17).

Every 4000 Km. (2400 mls.):

1. Change oil in gear case (see page 25). This should also be carried out after the first 1000 Km. (600 mls.).

2. De-coke the engine (see page 28) (cylinder head, piston crown and cylinder ports). Ensure

that no residual carbon deposits remain inside the cylinder. Clean the exhaust pipe using a hooked steel wire.

3. Grease front hub through the nipples and lubricate the speedometer drive and transmission, the brake lever and gear selector.

4. Remove the air filter (see page 24), clean by agitating in a petrol bath and if possible air blast dry.

Every 8000 Km. (4800 mls.):

1. Lubricate control cables and felt lubricating pad on flywheel. (**Consult your Service-Station**).

2. Clean and if necessary, adjust the contact breaker points (fig. 19). To avoid faulty ignition or other defects check the flywheel timing (see page 28). **Refer to your Dealer for this operation.**



LAYING UP

We recommend the following operations:

1. Clean down the vehicle.
2. With the engine stationary and throttle fully opened, introduce 40 cc. of engine oil through the hole provided on the air cleaner case (see page 24). After said operation depress the kick-starter three or four times.
3. Drain off all fuel in the fuel tank; then grease all unpainted metallic parts.
4. Raise the wheels off the ground by placing wooden chocks under the footrest.



CLEANING THE VEHICLE

1. Engine

For cleaning the exposed surface of the engine use paraffin, a brush and clean rags.

2. Bodywork

Washing and polishing operations should not be carried out in the sun, particularly during the summer when the bodywork is warm.

Under no circumstances should petrol or Diesel oil be used for washing painted surfaces or plastic material as they will deteriorate and lose their sheen.

Always wash paintwork before polishing.

— Washing

Wash down using a low pressure hose. Do not use a high pressure system as grit may be forced into the painted surface. As road dirt, etc. becomes soft sponge down using a car-type shampoo if desired.

First lightly sponge down the painted surface then gradually exert more pressure in order to remove stains, etc. Wash frequently to avoid

damage by abrasives picked up from the road surface. Rinse thoroughly and dry using a clean chamois leather.

— Spots

Marks which prove difficult to remove caused by tar, oil, grease and squashed insects, etc. should be removed as soon as possible using a soft rag dipped in oil or turpentine. The affected area should be cleansed with water as soon as possible afterwards.

— Polishing

Should the previous operations not bring the paint work to its original brightness or if painted surface has deteriorated for want of care, by the effect of the sun, dust or rain, it is necessary to introduce a polishing operation. For that, use "Polish" or similar products of good quality.

Apply "Polish" by means of a soft rag and by lightly rubbing uniformly the surface; the rubbing movement should be alternate and not circular.

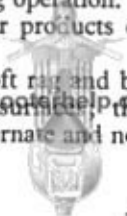

SUMMARY OF INSTRUCTIONS FOR MAINTENANCE AND LUBRICATION

Principal operations to carry out			Lubricants
2000 Km. (1200 mls.)	Every— 4000 Km. (2400 mls.)	8000 Km. (4800 mls.)	
<p>Gear box (top up)</p> <p>Cleaning and adjusting sparking plug electrodes</p>	<p>Fulcrum points of brake lever and pedal</p> <p>Gear selector</p> <p>Front suspension</p> <p>Speedo drive and transmission</p> <p>Cleaning air filter (in petrol)</p> <p>Decoking cylinder head and piston</p> <p>Decoking silencer</p>	<p>Gear box (Change oil)</p> <p>Greasing control cables★</p> <p>Felt lubricating pad on flywheel★</p> <p>Cleaning and adjusting contact breaker points (check timing★)</p>	See lubrication chart. Page 16.
<p>Engine: At each refilling (lubricated by oil in mixture)</p>			
<p>Front and rear dampers (only if defective★)</p>			

★ Consult your Service Station

scooterhelp.com



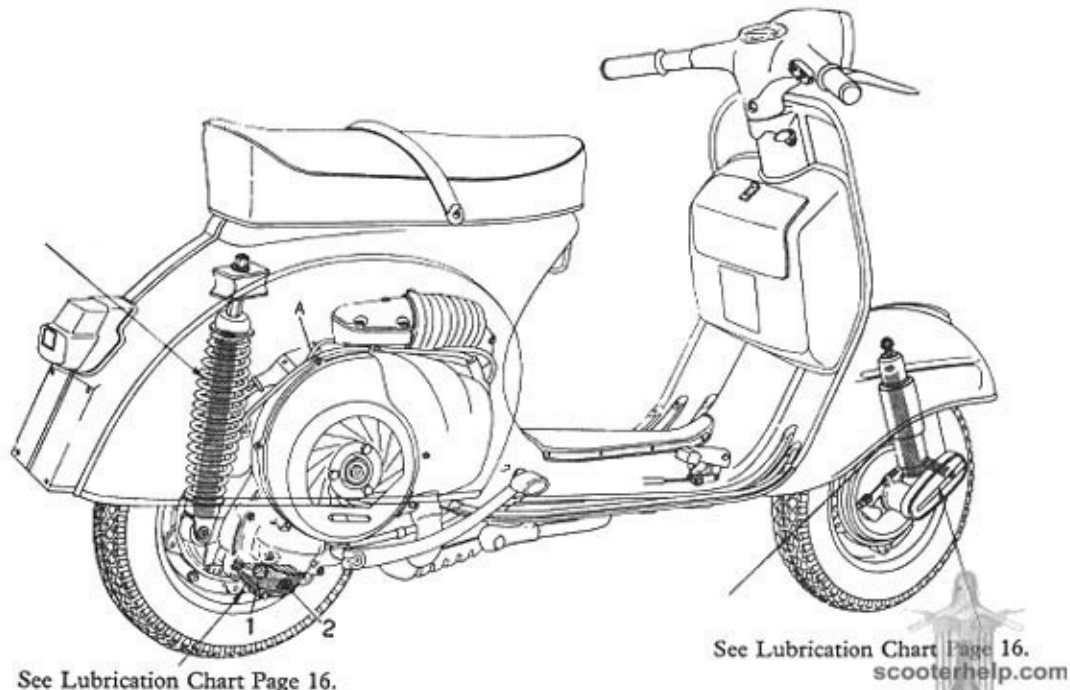

See Lubrication Chart Page 16.

See Lubrication Chart Page 16.
scooterhelp.com

Fig. 21—Lubrication scheme.

A. Engine lubricated by fuel mixture (5% by volume). 1. Oil filler hole. 2. Oil draining hole.

FAULT FINDING

If the machine does not run properly, inspect and rectify as explained below.

If the suggested remedies are not sufficient to eliminate the trouble, consult your Dealer.

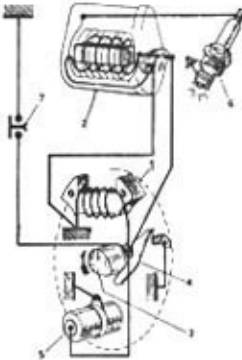
Fault finding	Remedies	Notes
<p>HARD STARTING</p> <p>1. Fuel system. Carburation. Ignition.</p> <p>Lack of fuel</p> <p>Filter, jets, fuel tap, carburettor body clogged or dirty.</p> <p>Engine flooding.</p> <p>Air cleaner choked or dirty.</p> <p>Sparking plug dirty. Porcelain of sparking plug cracked.</p>	<p>Turn to Reserve and refill as soon as possible.</p> <p>Remove, wash in petrol and blow dry.</p> <p>See page 18.</p> <p>See page 24.</p> <p>Disconnect the plug lead. Check if sparking occurs between lead and crankcase when the kick-starter is operated.</p>	<p style="text-align: center;">Notes</p>  <p style="text-align: center;">Fig. 22 Ignition circuit</p> <p>1. Flywheel coil. 2. H.T. coil. 3. Flywheel cam. 4. Contact breaker. 5. Denser. 6. Sparking plug. 7. Engine cut-out.</p>

Fault finding	Remedies	Notes
<p>Breaker points dirty, worn or pitted; gap between breaker points incorrect.</p> <p>VARIOUS RUNNING DEFECTS</p> <p>1. Lack of power. Spark plug misfiring (see fig. 22).</p> <p>Silencer (or engine) choked.</p> <p>Spark plug loose in the cylinder head.</p> <p>Cylinder head loose.</p> <p>2. High fuel consumption. a) Air filter choked or dirty or choke control set in closed or partially closed position.</p>	<p>Consult your dealer.</p> <p>Clean or replace. Clean the contact breaker. Check the electrode gap of the sparking plug, check the flywheel timing (see page 29).</p> <p>Clean (see page 33).</p> <p>Tighten with a wrench.</p> <p>Set head accurately and tighten nuts uniformly.</p> <p>Wash in neat petrol, air blast dry. Free off starter device lever and lubricate.</p>	<p>Notice: When overhauling fill with 6' cm of grease the seat of the main bearing flywheel side.</p> <p>When overhauling the front suspension, grease the wheel bearings. See lubrication chart page 16</p> <p style="text-align: right;">  scooterhelp.com </p>

Fault finding	Remedies	Notes
<p>b) Other causes (carburettor, lack of compression, etc.).</p> <p>3. Noisy engine. Defective suspension. General mechanical failures.</p> <p>4. Defective electrical equipment.</p> <p>Wire terminals disconnected or incorrectly connected.</p> <p>Headlight beam incorrectly set.</p> <p>Defective bulbs.</p>	<p>Consult your Dealer.</p> <p>Consult your Dealer.</p> <p>Carefully check and connect.</p> <p>Adjust (see page 32).</p> <p>See page 28 for substituting.</p>	

GENERAL SPECIFICATION

Engine (see characteristics at page 8 and fig. 4): The engine is pivoted to the chassis of the vehicle (fig. 3). The rear wheel is fitted on the outer side of the main shaft.

Lubrication of engine (piston, cylinder, crankshaft) is effected by the oil in the fuel mixture. Clutch, main bearing, clutch side, and gear box function in an oil bath.

Main bearing, flywheel side, lubricated by the grease content introduced during assembly.

Fuel supply (see fig. 10): gravity feed with mixture of oil and petrol.

Three way tap ("closed", "open", "reserve"). Carburettor provided with a throttle slide and starter device; air intake located inside the frame.

Clutch (see fig. 4): multiplate.

Gear box (see fig. 9): four speed drive with constant mesh gears. Operated by the twist grip on L.H. handlebars which functions in conjunction with the **clutch** control lever.

Transmission ratio engine to driving wheels:

Bottom gear	1:14.466
2nd gear	1:10.088
3rd gear	1: 7.461
4th gear	1: 5.710

Starting (see fig. 7): by means of a kickstarter on the R.H. side of the vehicle.

Cooling by means of a centrifugal fan.

Integral chassis (see fig. 1): of pressed sheet steel with streamlined monocoque type structure. It is completed, for protective means, by lateral cowls and mudguard.

Handlebars: Light alloy casting **comprising speedometer** and trapezoidal shaped head-lamp. All transmission cables and various controls are concealed in casting.

It is arranged for easy fitting of a windscreen (accessory).

Steering column, suspension: On the lower end of the steering column is pivoted the front wheel swinging hub: front and rear suspensions



with helical spring and double acting hydraulic damper. **Dual seat.** **Security lock** on the steering column.

Wheels: Interchangeable and made up of 2.45" pressed steel flanges, onto which are mounted 3.50-10" tyres.

Brakes: Mechanical, expanding type. Front brake is operated by hand, the rear brake is pedal operated.

Controls: clutch, gear box, throttle, front and

rear brake, choke, provided with flexible and adjustable cables.

STANDARD TOOL KIT (contained in the front tool box) two ended box wrench (17, 21 22 mm.); and (11, 14 mm.); one double open-ended wrench (11, 14 mm.); three single open-ended wrenches (7, 8, 10 mm.). One lever for wrenches and 1 screwdriver.

Accessories

Consult your Dealer.

ELECTRICAL EQUIPMENT

On this vehicle the electrical plant is provided with a 6V. 12 Ah battery, which feeds the horn, stop light and pilot lights; the battery is fed by the flywheel magneto by means of a rectifier-diode. On the handlebars, located on the headlamp housing, there is a 5 way lighting and warning switch which includes an ignition switch.

For battery maintenance top up periodically with distilled water and see instructions on appropriate guarantee sheet.

— **The rear lamp** is provided with a 6V. 5W. bulb (red pilot light and light for registration plate) and a 6V. 10W. bulb (Stop light).

— **Horn.**

— **Speedometer light** (6V. 0.6 W. bulb).



Fig. 23—Installation of electrical equipment.

1. Black. 2. White. 3. Green. 4. Brown. 5. Violet. 6. Red. 7. Blue. 8. Yellow. 9. Pink. 10. Grey.

Light and dip switch: P: Pilot light on; engine cut-out 0: Lights off; engine cut-out 1: Day-time running 2: Running by night with pilot lights on. 3. Running by night with head light on.

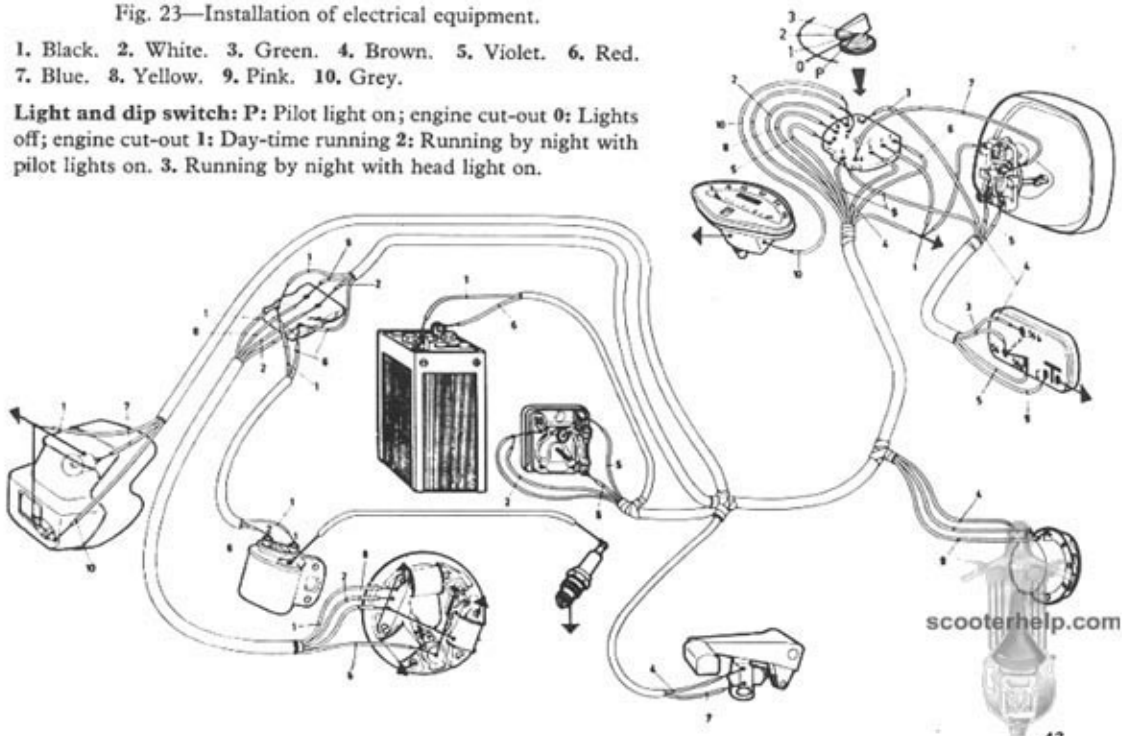

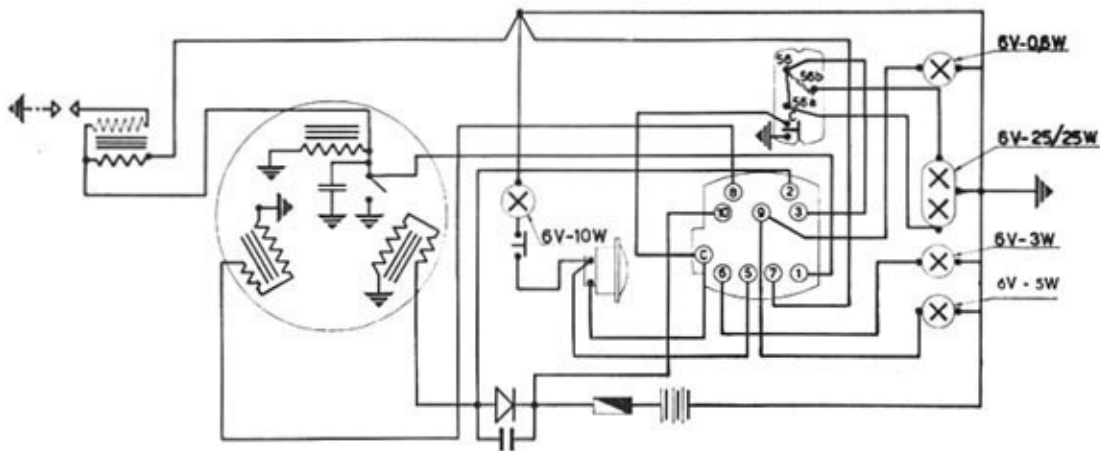

Fig. 24—Wiring diagram.

Connections on switch unit P: contacts 1-3 and separately, 10-9-6-0: contacts 1-7-1: contacts 10-5-2: contacts 10-9-5-6 and separately 2-8-3: contacts 10-5 and separately 2-3-8-9.

Following lighting and signalling devices are supplied:

- with a.c. (from the six pole flywheel magneto) in the position 3 of the main switch (fig. 23) for feeding: a 25/25W bulb (main and dipped beam); a 5W bulb (number plate light); a 0.6W bulb (speedo. light).
- with d.c. (6V 12Ah battery fed by the flywheel magneto by means of a rectifier-diode) for feeding the horn; a 3W bulb (pilot light); a 5W bulb (number plate light); a 0.6W bulb (speedo. light); a 10W bulb (stop light), in the position 2 of the main switch (fig. 23).

IDENTIFICATION DATA: consist of a prefix VSC 1 and progressive number. The chassis prefix and serial number, stamped on the frame and engine, identify the vehicle as

prescribed by law, are always carried on the documents pertaining to the vehicle: **said series should be quoted when ordering spare parts.**

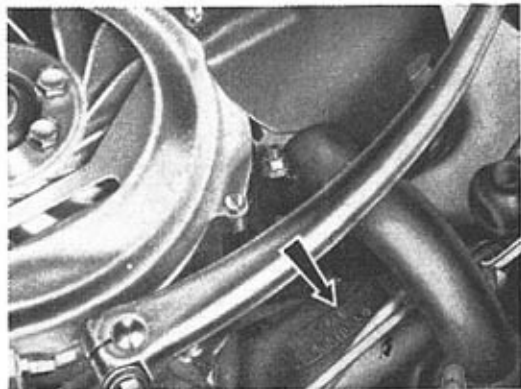
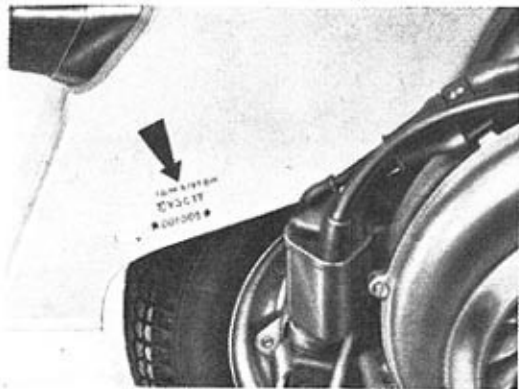

Fig. 25—Serial number stamped on frame (VSC 1 T.....) and on engine (VSC 1 M.....)

scooterhelp.com



The descriptions and illustrations in this booklet are not to be taken as binding on the Manufacturer. The essential features of the model described and illustrated herein remaining unaltered, Douglas (Sales & Service) Ltd. reserves therefore the right to carry out at any moment, without being obliged to bring this

booklet up-to-date in due course, modification that may occur concerning machine units and parts, or delivery of accessories, that the Firm deems to be convenient on improvement purposes of for what may concern manufacturing or commercial requirements.

